

**autOTEK<sup>®</sup>**  
EVOLUTION OF POWER

**SUPER SPORT  
AT-SERIES  
AMPLIFIERS**

**AT1000 / AT1500 / AT1200 / AT2000.1 / AT3000.1**

# SUPER SPORT AT-SERIES AMPLIFIERS

Autotek is proud to introduce the finest high end car audio products available and would like to thank you for your continued support. The Super Sport AT-Series amplifiers have been designed to a very high level of performance, with features unavailable in any other products. All of the amplifiers have variable crossovers built in, with added touches such as High Level Inputs, Bass Equalization, Wide Range Crossover controls with High Pass, Low Pass and selectable Mono / Stereo selector switch.

To insure years of listening pleasure, all amplifiers have a built in diagnostic mode that will detect shorted speaker leads, low impedance, dangerous high temperatures, DC shorts and will shut down the amp to help prevent serious damage.

---

INDEX	PAGE
General Installation Procedures.....	1
- Mounting the amplifier / Wiring Requirements	
Amplifier Feature Descriptions.....	2
AT1000 / AT1500 / 2-CHANNEL AMPLIFIER APPLICATIONS.....	3-4
- Full range stereo / Full range mono / 2 way active with mono bass using two 2 channel models	
AT1200 / 4-CHANNEL AMPLIFIER APPLICATIONS.....	5
- Full range stereo / 3 channel full range system	
AT2000.1 / AT3000.1 / 1-CHANNEL AMPLIFIER APPLICATIONS.....	6
- Basic A/B mono amplifier application	
Features and Specifications.....	7
Setting Up Systems After Installation For Best Performance.....	8
Troubleshooting and Diagnostics.....	9
Product Warranty.....	10

---

## Available Optional Equipment

### ATK2/3X

2-Way / 3-Way Active Crossover with Remote Bass Control

- 2 & 4 channel inputs / Sub-Input for receivers with Sub Outputs / Bass Remote offers 12dB Bass Boost / Adjustable Level Output to 8.5 volts /
- 180 degree Phase Shift / 45Hz Bass Boost with Quasi-Parametric EQ / Level (gain) adjustments for front, rear and sub outputs / 2nd Order Butterworth
- Hi-Pass for front and rear channels

### 7007

4-Band EQ / 9 Volt Line Driver Signal Processor

- 4 band EQ and Line Driver / Dual Inputs with Level Matching / DIN, ISO Mount chassis / EQ controls with 12dB of Bass Boost - cut 45Hz Sub Bass - 120Hz
- Mid Bass - 2.2KHz Mid Range - 12KHz Treble / Master Volume and Subwoofer Volume / Front to Rear dual amp Fader / High Pass F/R Crossover - 12dB Slope / Selectable Subwoofer Output - 50Hz - 80Hz - 120Hz at 18dB Slope

### MLX-100 Maxx-Link

Universal Linking (Strapping) Module

- Allows you to link (strap) multiple mono amplifiers into a Master/Slave configuration / Remote Level control with Clipping Indicator built-in & Master-Slave
- Control Switch / 24dB Adjustable Low Pass Filter 35Hz-250Hz / Built-In 65Hz Test Tone for Level matching / 24dB adjustable Subsonics Filter 15Hz-35Hz
- 10dB Adjustable Parametric Bass EQ / Variable Wide-Narrow Band Width control / 0-180 Degree Phase Shift / direct control of to 5 pairs of amplifiers & more with Y-Cables / Pre-Soft and Hard Clipping Indicators on Bass Remote and Main Module.

**The contents of this manual may not be reproduced or copied with out the written consent of MAXXSONICS USA, Inc.**

# GENERAL INSTALLATION PROCEDURE

## System Design

The success of any car stereo system relies on several factors, such as the system design, execution of the installation, and system setup. Please remember that any system is only as good as its weakest link.

Please remember that higher power systems are not necessarily useful purely for high sound pressure levels, but also to establish a headroom capability, to reproduce musical peaks cleanly without distortion. Lower power amplifiers will clip earlier than their more powerful cousins, and cause loudspeaker failure when overdriven, due to the harmonics generated by a clipped signal, thus overheating voice coils.

Amplifiers should be mounted with the fins running horizontally for best convection cooling, to minimize overheating. Purchase the best quality RCA cables you can afford, for reliability and less engine noise interference in the audio system.

## Installation

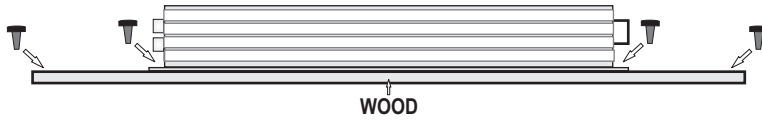

It is highly recommended that the amplifier be mounted to a board of MDF or other solid structure using the 4 mounting screws provided. Avoid mounting the amplifier to metal as this can introduce noise and other unwanted issues. When mounting the amplifier, ensure that it is mounted HORIZONTALLY, as shown in the diagram above, for optimal heat dissipation. Mounting amplifiers to speaker enclosures is not recommended as this can cause damage to the amplifier components. When choosing a location for mounting the amplifier, ensure that you check for clearance from wires, gas tank, electrical devices and brake lines etc.

### General:

Run the wiring so that RCA cables are at least 18" away from power and speaker cables. Keep RCA cables away from electrical devices in the vehicle that can cause electrical noise, such as electric fuel pumps, emission control modules and other on-board electronic modules.

### Power and Ground Connections (see the features matrix on page 7 for proper gauge cables per amplifier):

Use a sufficient gauge power cable and ground cable using the chart below as reference to what size wire you require. AT-Series amplifiers require minimum 4 gauge power wire. In a multi-amplifier system, add the total value of the manufacture recommended fusing to get your total system amperage. Some applications may require multiple runs of power wire to meet the system requirements. In multi amplifier systems it is advisable to mount a large enough fuse right at the battery, and run one or multiple +12 volt power cables to a fused distribution block near the amplifiers. It is then a simple matter to connect the +12 volt terminal of each amplifier to the distribution block. During this process, please ensure that the main power fuse is removed to avoid shorting the electrical system. Although the amplifier may be fused directly, a main fuse must be installed on the main power cable with-in 12" of the vehicles battery.

Ground each amplifier with as short a ground lead as possible directly to the vehicle chassis using 4 gauge wire or equivalent to the size of the amplifiers' power wire. Use a ground distribution block, if you wish, but it is extremely important to keep the main ground lead from this distribution block to the chassis as short as possible, not more than 12". The ground connection integrity to the chassis is very important, and the best way to achieve a good, solid electrical and mechanical contact is to use a large round crimp lug, crimped and soldered to the ground cable. The next step is to scrape the paint off the vehicle chassis, slightly larger than the ground lug, at the connection point. Drill a clearance hole in the chassis, the same size as the lug hole, and use a bolt, spring washer and nut to securely fasten the ground lug. Use petroleum jelly to coat the bolt/lug connection, to prevent oxidization with time.

**TIP:** Use the same approach when installing head units, equalizers or any audio equipment for that matter - run short individual grounds from each piece directly to the vehicle chassis, to minimize ground loops and system noise. All power, ground and speaker connections should be crimped and soldered for reliability. Make sure that none of the cable insulation can chafe against exposed metal in the vehicle, causing short circuits to the chassis.

WIRE LENGTH

SYSTEM AMPERAGE	7-10 ft.	10-13 ft.	13-16 ft.	16-19 ft.	19-22 ft.	22-28 ft.
35-50	8	6	4	4	4	4
50-65	6	4	4	4	4	2
68-85	4	4	2	2	2	0
85-105	4	2	2	2	2	0
105-125	4	2	0	0	0	0
125-150	2	0	0	0	0	0

WIRE GAUGE

**NOTE: This Matrix is a general rule of thumb. Please refer to the manufacturers specific requirements. Super Sport specifications can be found on page 7.**

### Safe connection sequence:

After all cables are run, connect speaker wires to the speakers and amplifiers, then run and plug in RCA cables. Next, connect all power, ground, and remote turn on leads. Now connect all +12 volt cables to the amplifier/s and distribution blocks and fuse holders. Finally, connect the main +12 volt cable to the battery, with the main fuse removed, and we are almost ready to power up the system.

### Power up the system:

The following procedure may seem like overkill, but there is nothing more frustrating when turning on a system for the first time, and it does not work properly immediately.

First, make sure the head unit is off, and turn all level controls to minimum (counterclockwise), including the head unit volume control. Set all equalizers to 0 dB (no boost), and all crossover frequency controls at approximate frequencies, as recommended by the loudspeaker manufacturer. Set all input selector and crossover switches as required for the application. Remove all amplifier fuses, and insert the main fuse at the battery. If the fuse does not blow, you can insert the fuse in one of the amplifiers, and we are ready to turn on the system. Turn the head unit on, insert a CD, or select a radio station, and increase the head unit volume control. If the system sounds fine, turn off the head unit, and install fuses in the remaining amplifiers, one by one, till the complete system is powered up and functioning properly.

# AMPLIFIER FEATURE DESCRIPTIONS

## SUPER SPORT AT-SERIES AMPLIFIERS:

- Each model is capable of 4 & 2-Ohms stereo per channel, or 4-Ohms mono bridged operation except the mono amps which are capable of 4, 2 and 1-Ohm loads.
- Tri-Mode operation with any stereo pair of amplifier channels is possible, as with all bridgeable amplifiers.
- The input sensitivities for rated output powers are variable from 0.2 volt to 5 volt.
- All crossovers are fully variable in their respective ranges.
- Crossover filters are 12dB/Octave.
- A **POWER** LED indicates the powered up and turned on condition.

- All Autotek amplifiers feature a comprehensive diagnostic system, with speaker lead short circuit, and amplifier DC faults indicated by the red "PROTECT" LED.
- **CAUTION: DO NOT OPERATE ANY AMPLIFIER BELOW THE INTENDED IMPEDANCE.. YOU WILL CAUSE DAMAGE TO THE AMPLIFIER THAT WILL NOT BE COVERED UNDER THE WARRANTY PRINTED IN THE BACK OF THE MANUAL. 2 & 4 Channel amps are capable of 4 and 2-Ohms wired stereo and 4-Ohms wired mono bridged. The mono amps are capable of 4, 2 and 1-Ohm.**

The **X-OVER** slide switch selects the internal crossover functions:

-The input signal is routed directly to the **LINE OUT** RCA jacks, regardless of the **X-OVER** setting simplifying daisy chaining of amplifiers.

-**HPF**: Selects the built in **HIGH PASS** filter, variable from 60 Hz to 1.2kHz.

-**FULL**: Bypasses all crossovers for full frequency range operation.

-**LPF**: Selects the built in **LOW PASS**, variable from 30 Hz to 250Hz.

**MODE**: The mode switch allows you to choose Stereo for full range 2 channel operation or **MONO** for bridging operation

**HIGH INPUT**: If your radio/CD player does not have unbalanced (RCA) outputs, you can use the **HIGH** level (wire) inputs.

**LINE INPUT**: The line input accepts unbalanced (RCA) inputs from 0.2V to 5V.

**LINE OUTPUT**: The line output passes through signal from the line inputs which allows you to daisy chain multiple amplifiers from one signal.

### AT1000 / AT1500 2-CHANNEL AMPLIFIERS

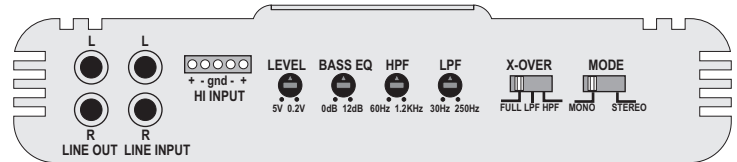

Note that the **LOW PASS** signal is **MONO**.

-In the **LPF** position, the **HIGH PASS** filter acts as a subsonic filter.

-When the **LPF** mode is selected, a 0 to +12dB, at 45Hz, **BASS-EQ** is also switched in.

The 4 channel amps have the same features as the 2 channel models except that there are 2 sets of controls.

1 set for channels 1 & 2 and 1 set for channels 3 & 4.

In addition, the 4 channel models have a **Mode** switch which allows you to select 2, 3 or 4 channel operation.

The **X-OVER** slide switch selects the internal crossover functions:

-The input signal is routed directly to the **LINE OUT** RCA jacks, regardless of the **X-OVER** setting simplifying daisy chaining of amplifiers.

-**HPF**: Selects the built in **HIGH PASS** filter, variable from 60 Hz to 1.2kHz.

-**FULL**: Bypasses all crossovers for full frequency range operation.

-**LPF**: Selects the built in **LOW PASS**, variable from 30 Hz to 250Hz.

**MODE**: The mode switch allows you to choose Stereo for full range 2 channel operation or **MONO** for bridging operation

**HIGH INPUT**: If your radio/CD player does not have unbalanced (RCA) outputs, you can use the **HIGH** level (wire) inputs.

**LINE INPUT**: The line input accepts unbalanced (RCA) inputs from 0.2V to 5V.

**LINE OUTPUT**: The line output passes through signal from the line inputs which allows you to daisy chain multiple amplifiers from one signal.

### AT1200 4-CHANNEL AMPLIFIER

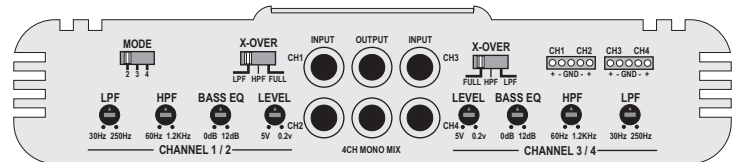

Note that the **LOW PASS** signal is **MONO**.

-In the **LPF** position, the **HIGH PASS** filter acts as a subsonic filter.

-When the **LPF** mode is selected, a 0 to +12dB, at 45Hz, **BASS-EQ** is also switched in.

### AT2000.1 / AT3000.1 1-CHANNEL MONO AMPLIFIERS

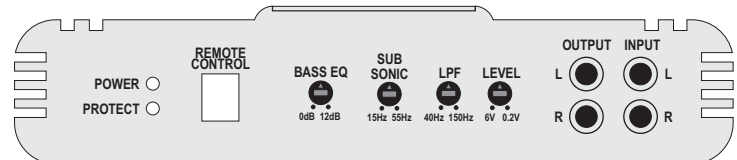

The mono amps are capable of 4, 2 & 1-Ohm loads.

Operating the amp below 1-Ohm can cause damage to the amp not covered in the warranty.

# AT1000 / AT1500 / 2 CHANNEL AMPLIFIER APPLICATIONS

## FULL RANGE STEREO

This is the most basic application for the SUPER SPORT Series 2 channel amplifiers.

### 1. Interconnect cable checklist:

Connect the **LINE INPUTS** to the Radio/CD with good quality RCA cables.

### 2. Crossover Switch:

The **X-OVER** switch must be in the **FULL** position.

### 3. Crossover frequency control checklist:

N/A for full range operation.

### 4. Line Level:

Refer to the section "Setting up systems after installation for best performance".

### NOTE: Minimum final loudspeaker impedances:

**4 & -2-Ohms stereo mode or 4-Ohms mono mode**

**This amplifier will not do 1-Ohm stereo or 2/1-Ohm mono operation.**

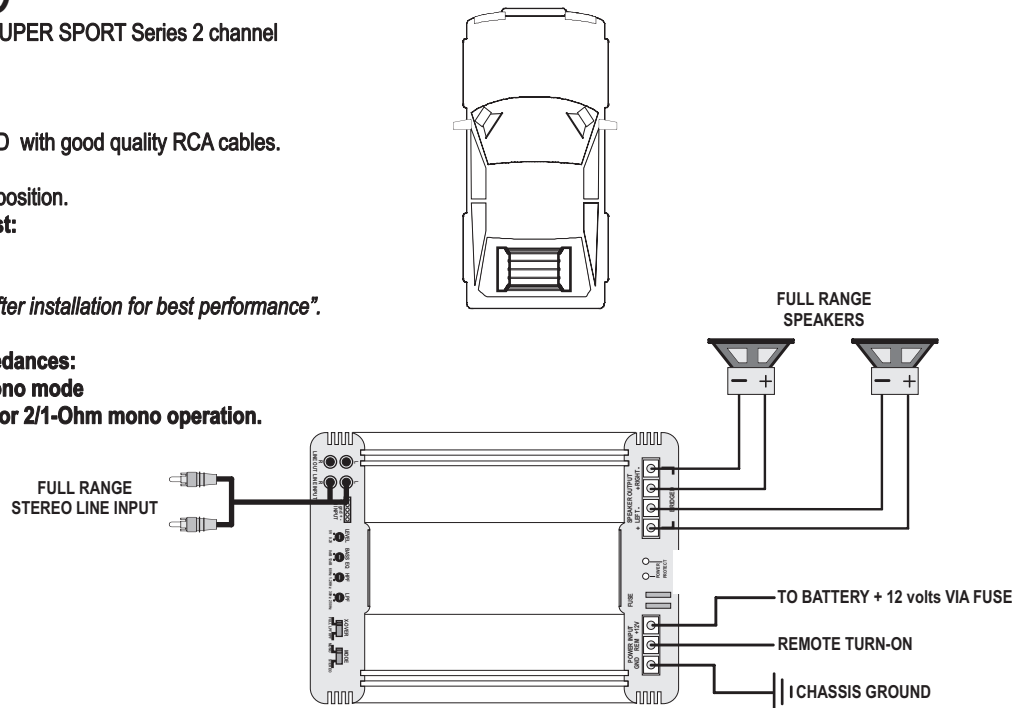

## FULL RANGE MONO

This application illustrates the basic mono bridging method for all Autotek 2 channel amplifiers.

### Interconnect cable checklist:

A **MONO** signal source is required, such as would be available from the mono sub bass output of an active crossover, whether stand alone, or built into a head unit or equalizer. **Important:** Do not be tempted to connect the hot, or positive outputs, from any source together to obtain a mono signal, as this could very well damage the output stage of that source.

It is necessary to feed the **SAME** signal to both left and right inputs via a Y-adaptor RCA cable. Connect the mono speaker positive terminal to the **LEFT +**, and its negative terminal to **RIGHT -**.

### Switch setting checklist:

- The **AMPLIFIER X-OVER** switch must be in the **FULL** position.

### Crossover frequency control setting checklist:

N/A for full range operation.

**TIP:** If you are using the mono sub bass output of an active crossover, there is nothing wrong with switching in the low pass filter in these amplifiers for a steeper low pass roll-off.

### Minimum final loudspeaker impedance:

- **4-Ohms mono.**

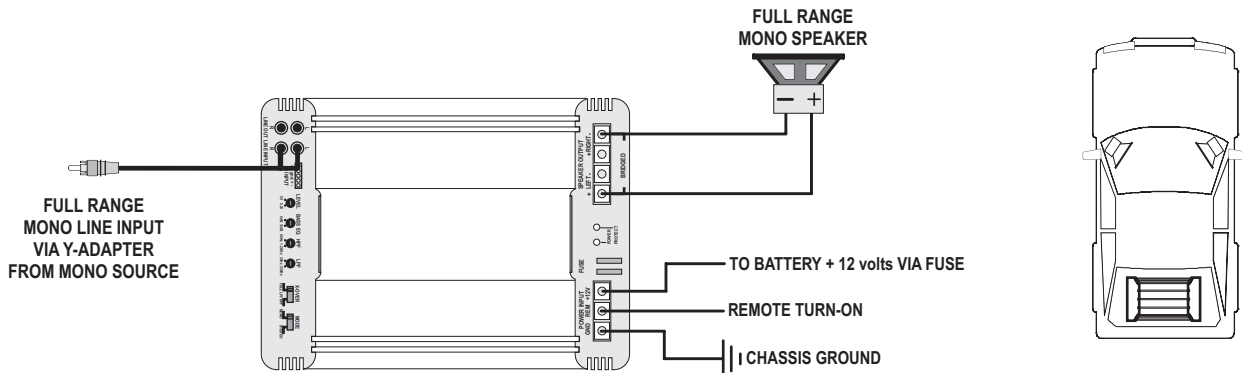

The **HIGH LEVEL** inputs are used when the radio/CD player does not have RCA cable outputs. You can connect the radio/CD player speaker wires directly to the amplifier via the high Level Inputs.

Use this connector for 2 CH amplifiers

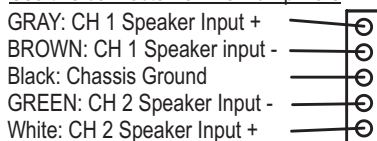

# AT1000 / AT1500 2-CHANNEL AMPLIFIER APPLICATIONS

## Stereo high pass with mono low-pass in a 2 way active, or bi-amplified system

In this application we will use a 2 channel amplifier for the high frequencies, and a second one for the low frequencies, or mono sub bass. Please consult the speaker specifications to determine maximum amplifier power requirements.

### Interconnect cable checklist:

Connect the inputs of the HIGHS amplifier to a Radio/CD with good quality RCA cables. Connect the LINE OUT of the HIGHS amplifier to the inputs of the BASS amplifier with a stereo RCA to RCA cable.

### Mono bass woofer wiring:

Connect the mono speaker positive terminal to the LEFT +, and its negative terminal to RIGHT -.

### Switch setting checklist:

- Highs amplifier: X-OVER switch in the HPF position.
- Lows amplifier: X-OVER switch in the LPF position.

### Crossover frequency control checklist:

#### Highs amplifier:

- HI PASS: 100 Hz
- LOW PASS: N/A

#### Lows amplifier:

- HI PASS (Subsonic filter): 30 Hz to 50 Hz
- LOW PASS: 100 Hz

Please note that these frequency points are suggestions only. Refer to the loudspeaker manufacturer specifications and the section "Setting up systems after installation for best performance"

#### Level control checklist:

- Refer to the section "Setting up systems after installation for best performance"

#### Minimum final loudspeaker impedances:

- 2-Ohms per channel stereo.
- 4-Ohms mono bridged.

**CAUTION:** This amp is not capable of 1-Ohm wired stereo, 2 or 1-Ohm wired mono bridged. Lower than recommended impedance will damage the amp and could possibly void the warranty.

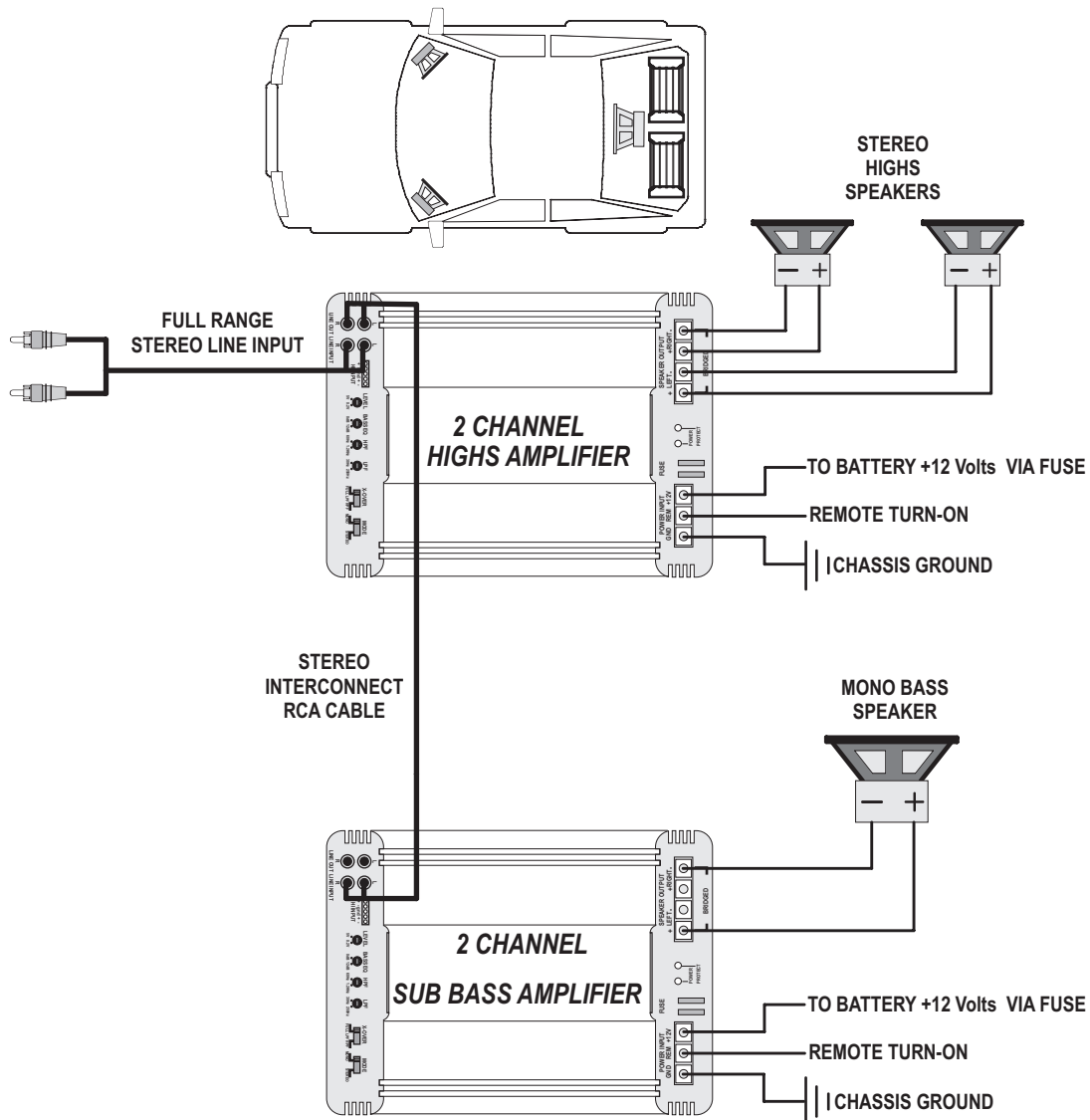



# AT1200 / 4 CHANNEL AMPLIFIER APPLICATIONS

## 4 CHANNEL FULL RANGE SYSTEM

Here we show how to use the 4 channel amplifiers as straight forward discrete 4 channel full range units.

### Interconnect cable checklist:

- Connect the four inputs of the amplifier to a Radio/CD with quality RCA cables.

### Switch setting checklist:

- 1/2CH X-OVER: FULL  
- 3/4CH X-OVER: FULL

### Crossover frequency control checklist:

#### Channels 1/2:

- HI PASS: N/A  
- LOW PASS: N/A

#### Channels 3/4:

- HI PASS: N/A  
- LOW PASS: N/A

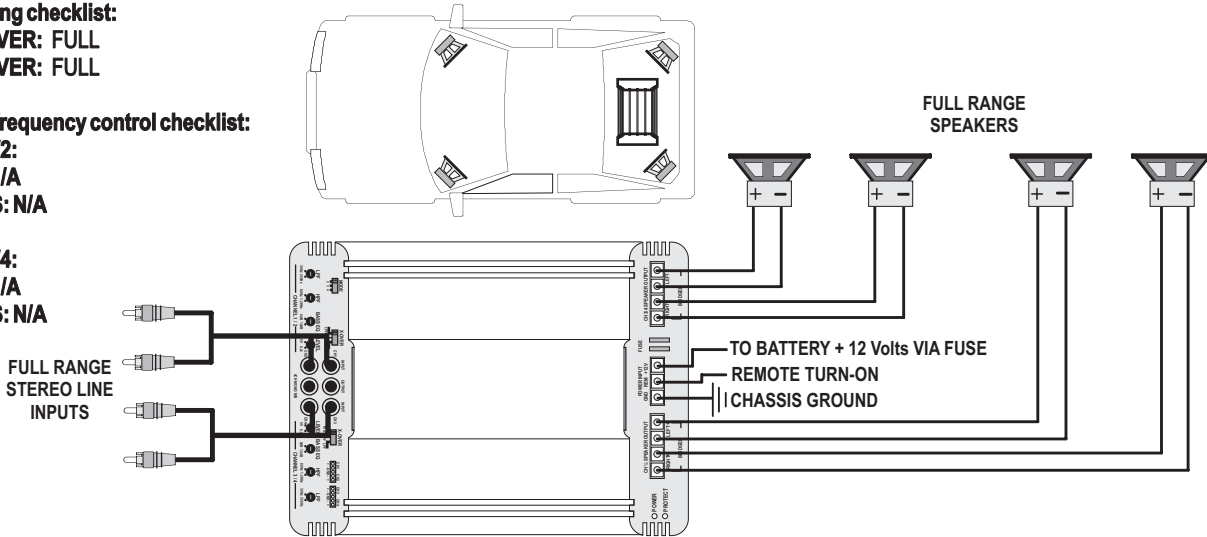

### Level control checklist:

- Refer to the section "Setting up systems after installation for best performance"

### Minimum final loudspeaker impedances:

- 2-Ohms per channel.

## 2 or 3 CHANNEL FULL RANGE SYSTEM

Here we show how to use the 4 channel amplifiers as full range 2 or 3 channel units by taking advantage of the mono bridging capability of all AutoteK amplifiers.

The following example shows how to create a 3 channel system by mono bridging channel pair 3 / 4. In order to create a 2 channel system, simply follow the example to also mono bridge channel pair 1 / 2.

### Interconnect cable checklist:

- Connect the inputs of channel pair 1/2 to a suitable stereo source, e.g. a head unit with good quality RCA cables.

- A MONO signal source is required to bridge channel pair 3/4, such as would be available from the mono sub bass output of an active crossover, whether standalone, or built into a head unit or equalizer.

**Important:** Do not be tempted to connect the hot, or positive outputs, from any source together to obtain a mono signal, as this could very well damage the output stage of that source.

- It is necessary to feed the SAME signal to both left and right inputs via a Y-adapter RCA cable.

- Connect the mono speaker positive terminal to the LEFT +, and its negative terminal to RIGHT - as shown.

### Switch setting checklist:

- 1/2CH X-OVER: FULL  
- 3/4CH X-OVER: FULL

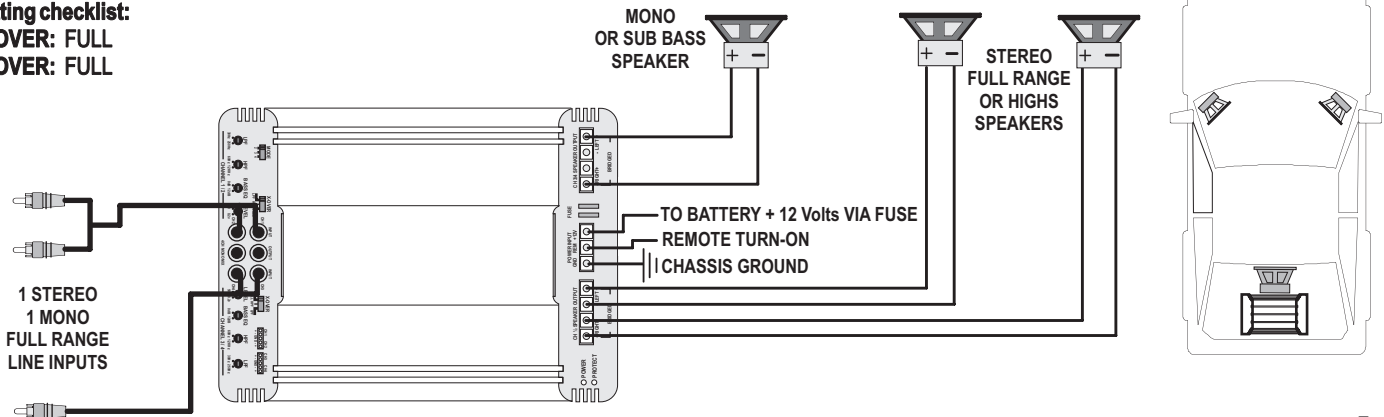

### Crossover frequency control checklist:

#### Channels 1/2:

- HI PASS: N/A  
- LOW PASS: N/A

#### Channels 3/4:

- HI PASS: N/A  
- LOW PASS: N/A

**TIP:** If you are using the mono sub bass output of an active crossover, there is nothing wrong with switching in the low pass filter in these amplifiers for a steeper low pass rolloff.

### Level control checklist:

- Refer to the section "Setting up systems after installation for best performance"

### Minimum final loudspeaker impedances:

- 2-Ohms per channel in stereo mode.  
- 4-Ohms mono bridged.

# AT2000.1 / AT3000.1 / MONO AMPLIFIER APPLICATIONS

## Basic application

These sub bass amplifiers can be used in any of the bi-amplification systems described in this manual, replacing the 2 channel amplifiers as per the illustrations.

### Interconnect cable checklist:

Connect the inputs to a suitable source, e.g. a head unit with good quality RCA cables. Connect the LINE OUT to the inputs of the system highs amplifier.

Use at least #12 gauge speaker wiring. The amps have dual speaker terminals, simplifying the hookup of multiple speakers

### Crossover frequency control checklist:

**LOW PASS: 35Hz to 250Hz**

**SUBSONIC: 15 Hz to 55 Hz**

**BASS EQ: 0 to +12dB**

**PHASE: 0 to 180 degrees**

### Level control checklist:

Refer to the section "Setting up systems after installation for best performance"

**Minimum final loudspeaker impedance: 1-Ohm.**

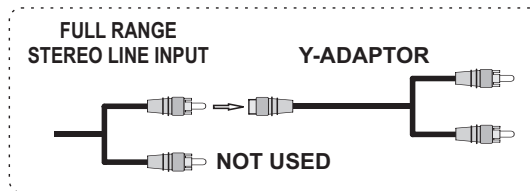
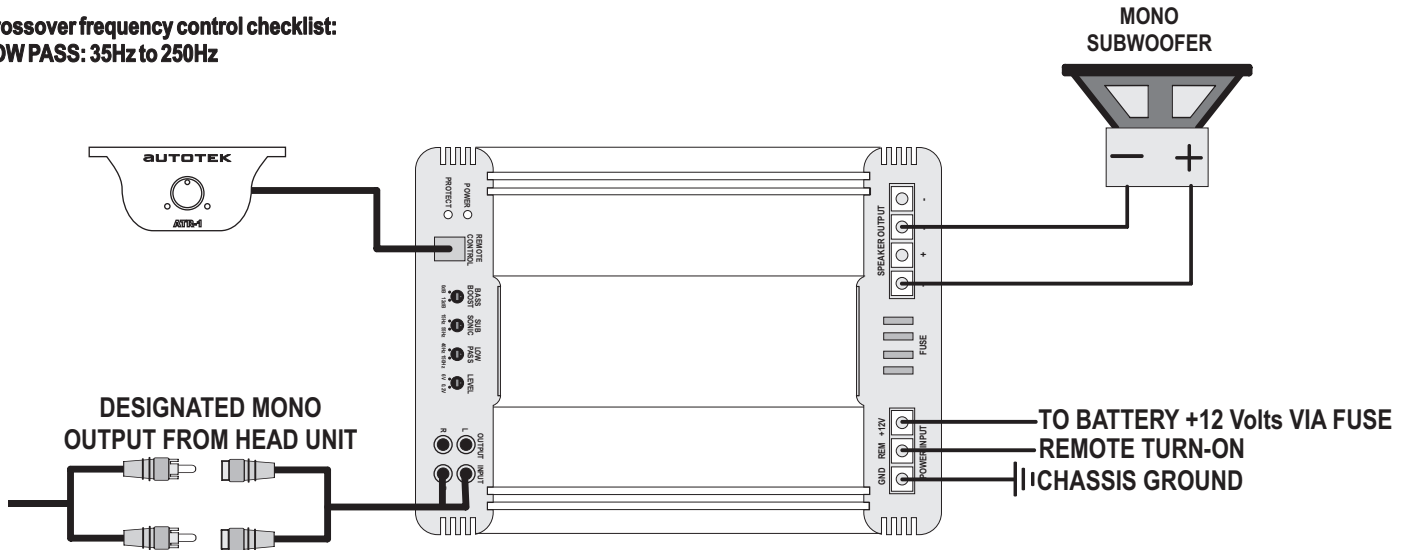

Note: You can use the Radio/CD designated mono line output or a full range stereo line output. For full range stereo line output, you will need an optional "Y-Adaptor" as shown

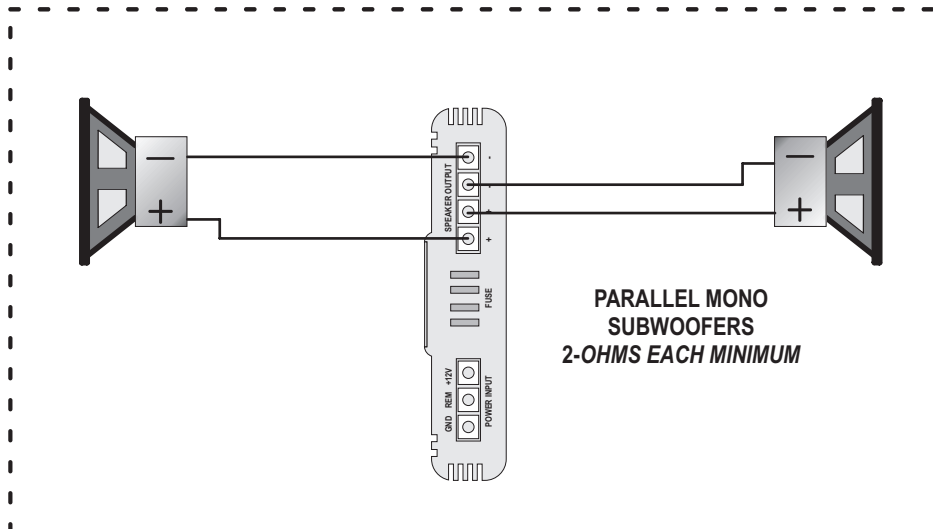



FEATURES	2-CHANNEL		4-CHANNEL		1-CHANNEL MONO	
	AT1000	AT1500	AT1200	AT2000.1	AT2000.1	AT3000.1
Output Power Rating						
4-Ohms	250 x 2	375 x 2	150 x 4	500 x 1	750 x 1	
2-Ohms	500 x 2	750 x 2	300 x 4	1000 x 1	1500 x 1	
1-Ohm	1000 x 1	1500 x 1	600 x 2	2000 x 1	3000 x 1	
Mono Bridge at 4-Ohms						
Miscellaneous Spec						
Soft Start Sound	Yes	Yes	Yes	Yes	Yes	Yes
Frequency Response-3dB	30Hz - 1.2KHz	30Hz - 1.2KHz	30Hz - 1.2KHz	15Hz - 300Hz	15Hz - 300Hz	15Hz - 300Hz
Damping Factor	>200	>200	>180	>200	>200	>200
S/N Ratio(A-Weight)	> 95dB	> 95dB	> 90dB	> 95dB	> 95dB	> 95dB
THD & N	<0.05%	<0.05%	<0.05%	<0.10%	<0.10%	<0.10%
Channel Separation	> 70dB	> 70dB	> 80dB			
Variable Input Level Control	0.2V-5.0V	0.2V-5.0V	0.2V-5.0V	0.2V-6.0V	0.2V-6.0V	0.2V-6.0V
Input Impedance	47kΩ	47kΩ	47kΩ	47kΩ	47kΩ	47kΩ
Diagnostic Indicator(power: green / protect: red)	Power/Protect	Power/Protect	Power/Protect	Power/Protect	Power/Protect	Power/Protect
Protection(DC, Short, Thermal, Overload)	Yes	Yes	Yes	Yes	Yes	Yes
Crossover Operation						
Crossover S/W for 1+2 channel	LPF / FULL / HPF	LPF / FULL / HPF	LPF / FULL / HPF	LPF / FULL / HPF	LPF / FULL / HPF	LPF / FULL / HPF
Variable Hi-Pass / Subsonic Filter	60Hz - 1.2KHz	60Hz - 1.2KHz	60Hz - 1.2KHz	60Hz - 1.2KHz	60Hz - 1.2KHz	60Hz - 1.2KHz
Variable Low-Pass (Mono 24dB)	30Hz - 250Hz	30Hz - 250Hz	30Hz - 250Hz	40Hz - 150Hz	40Hz - 150Hz	40Hz - 150Hz
Variable Subsonic Filter	No	No	No	No	15Hz - 55Hz	15Hz - 55Hz
Bass Boost at 45Hz	0 ~ 12dB	0 ~ 12dB	0 ~ 12dB	0 ~ 12dB	0 ~ 12dB	0 ~ 12dB
Crossover S/W for 3+4 channel	No	No	LPF / FULL / HPF			
Variable Hi-Pass	No	No	60Hz - 1.2KHz			
Variable Low-Pass (Mono 24dB)	No	No	30Hz - 250Hz			
Variable Subsonic Filter	No	No	No			
Bass Boost at 45Hz	No	No	No			
Line Output	Full Range	Full Range	Full Range	Full Range	Full Range	Full Range
Unbalanced Input(RCA Jack)	Yes	Yes	Yes	Yes	Yes	Yes
High Level Inputs	Yes	Yes	Yes	No	No	No
Phone Jack for Remote Control	No	No	No	Yes	Yes	Yes
Bass Boost Remote Control Module (ATR-1)	No	No	No	Yes	Yes	Yes
Others						
Power Terminal	4-GA	4-GA	8-GA	4-GA	4-GA	4-GA
Speaker Terminal	12-GA	12-GA	12-GA	10-GA	10-GA	10-GA
Fuse Size	2 x 30 Amp	2 x 30 Amp	2 x 15 Amp	4 x 25 Amp	4 x 30Amp	4 x 30Amp
Dimensions Length x Width x Height (inches)	9.85 x 9.85 x 2.17	12.6 x 9.85 x 2.17	10.24 x 9.85 x 2.17	15.75 x 9.85 x 2.17	17.72 x 9.85 x 2.17	17.72 x 9.85 x 2.17

Note: Features subject to change with out notice

# SETTING UP SYSTEMS AFTER INSTALLATION FOR BEST PERFORMANCE

---

## AT1000 / AT1500 / AT1200

### **General:**

At this point you are ready to get more specific on the settings for your amplifier.

### **High Pass:**

-When in Hi Pass operation, this setting acts as a low frequency cut off for your system reproduction. The point that you set it at cuts off any frequencies from reproduction beyond this point. The 12 o'clock position is a great starting point. EXAMPLE: If you adjust the High Pass to 100Hz, the amplifier will not play frequencies below 100Hz but will play frequencies from 100Hz to the chosen Low Pass frequency.

-When in Low Pass/Bandpass operation, this setting acts as a low frequency cut off for your system reproduction aka Subsonic Filter. The point that you set it at cuts off any frequencies from reproduction beyond this point. The 12 o'clock position is a great starting point. EXAMPLE: If you adjust the High Pass to 25Hz, the amplifier will not play frequencies below 25Hz but will play frequencies from 25Hz to the chosen Low Pass frequency.

-When in Flat/Full operation, the High Pass crossover is bypassed.

### **Bass EQ:**

This setting is a fixed bass boost at 45Hz that is variable from 0-12dB. This feature provides impact to your bass, but if not adjusted correctly, it can be over used and cause damage to your speakers and amplifiers. It is best to slowly turn this setting clockwise until the desired punch is felt. It is not recommended to exceed the 12 o'clock position unless listening at a low volume or a low recording quality as this can result in high distortion and possibly clipping.

### **Low Pass:**

The Low Pass control acts as a ceiling and doesn't allow frequencies to the right of the desired setting to be reproduced. Turning the potentiometer all the way to the right is a great starting point. EXAMPLE: If you adjust the Low Pass to 120Hz, the amplifier will not play frequencies above 120Hz but will play frequencies from 120Hz to the chosen Hi Pass or Subsonic frequency.

-When in Hi Pass operation, this setting is bypassed.

### **Level Control Setup:**

Ensure that the Level is turned completely to the left prior to turning the system on. Next you should insert a CD or cassette that you are familiar with to use as a reference, and turn the head unit volume control to about 80% of its full setting. The system sound level will of course be very low, and the following procedures will help you to match the amplifier input sensitivities properly to the head unit output signal level.

It is important to match the amplifier **LEVEL** input sensitivity to the Radio/CD output sensitivity. This can be located in the Radio/CD manual.

If the Radio/CD output sensitivity is 2 volts, then adjust the amplifier **LEVEL** input to 2 volts.

If you are not sure what the Radio output sensitivity is, follow these general guide lines:

Turn the level control up slowly, till you hear distortion, then back off a few degrees on the control. If at any point your amplifier goes into protection, you will need to turn the Level to the left a bit and then try again. If you reach a point where the output does not increase, stop turning the Level control to the right as the amplifier/speaker combo has reached its maxx output in this application.

### **2 or 3 way active systems (all):**

Always start with the bass, or low frequency amplifier as a reference, by turning its control up to the point where distortion is audible, and back it off some.

Now adjust the level control for the highs or tweeter channels in a 2 way active system, to balance the highs to lows.

In a 3 way active system, match the midrange level to the bass, and then the highs to the midrange and bass. It may be necessary to perform a few iterations of the midrange and highs level control

## AT2000.1 / AT3000.1

### **General:**

At this point you are ready to get more specific on the settings for your amplifier.

### **Subsonic:**

This setting acts as a low frequency cut off for your system bass reproduction. The point that you set it at cuts off any frequencies from reproduction beyond this point. The 12 o'clock position is a great starting point. EXAMPLE: If you adjust the Subsonic to 25Hz, the amplifier will not play frequencies below 25Hz but will play frequencies from 25Hz to the chosen Low Pass frequency.

### **Bass EQ:**

This setting is a fixed bass boost at 45Hz that is variable from 0-10dB. This feature provides impact to your bass, but if not adjusted correctly, it can be over used and cause damage to your subwoofers and amplifiers. It is best to slowly turn this setting clockwise until the desired punch is felt. It is not recommended to exceed the 12 o'clock position unless listening at a low volume or a low recording quality as this can result in high distortion and possibly clipping.

### **Low Pass:**

The Low Pass control acts as a ceiling and doesn't allow frequencies to the right of the desired setting to be reproduced. The 12 o'clock position is a great starting point. EXAMPLE: If you adjust the Low Pass to 80Hz, the amplifier will not play frequencies above 80Hz but will play frequencies from 80Hz to the chosen Subsonic frequency.

### **Phase:**

The variable Phase adjustment allows you to change the relative time that the waveform meets your ear. With standard subwoofer installations where the subwoofer is behind you, the Phase should generally be at 0. When subwoofers or woofers are in the kick panels or door panels, the Phase adjustment is useful in delaying the timing of the wave meeting your ear by adjusting the potentiometer to 180 degrees.

### **Level Control Setup:**

Ensure that the Level is turned completely to the left prior to turning the system on. Next you should insert a CD or cassette that you are familiar with to use as a reference, and turn the head unit volume control to about 80% of its full setting. The system sound level will of course be very low, and the following procedures will help you to match the amplifier input sensitivities properly to the head unit output signal level.

It is important to match the amplifier **LEVEL** input sensitivity to the Radio/CD output sensitivity. This can be located in the Radio/CD manual.

If the Radio/CD output sensitivity is 2 volts, then adjust the amplifier **LEVEL** input to 2 volts.

If you are not sure what the Radio output sensitivity is, follow these general guide lines:

Turn the level control up slowly, till you hear distortion, then back off a few degrees on the control. If at any point your amplifier goes into protection, you will need to turn the Level to the left a bit and then try again. If you reach a point where the output does not increase, stop turning the Level control to the right as the amplifier/subwoofer combo has reached its maxx output in this application.

**Sit back and enjoy the music!**

# TROUBLESHOOTING A SYSTEM

---

The key to finding the problem in a misbehaving sound system is to isolate parts of that system in a logical fashion to track down the fault.

## Description of the PROTECT system built into all Autotek amplifiers

The diagnostic system will shut down the amplifier, until reset by turning the head unit off, and back on. This state of affairs will be indicated by the front panel PROTECT LED lighting up under the following conditions:

- 1 - A short circuit on the loudspeaker leads.
- 2 - An internal amplifier fault that causes a DC offset on the loudspeaker output.

Should the amplifier go into protect mode, simply disconnect all RCA and speaker leads, while keeping +12 volt, power ground and remote leads connected.

1. Now turn the amplifier back on, and if the diagnostic LED lights, the amplifier has an internal fault.
2. If not, plug the RCA cables back, and reset the amplifier. If it goes into diagnostic now, the fault lies in the input, either with bad cables or source unit.
3. If the amplifier seems fine with RCA cables plugged in, connect the speakers, one at a time, and if one of the speakers or its wiring is faulty, it will activate the diagnostic system.

## Amplifier heatsink overheating

The amplifiers will shut down when the heatsink temperature reaches 80 degrees centigrade, and turn back on once the unit has cooled down below that point.

### Causes of overheating:

- 1 - Inadequate cooling - relocate or remount to provide better natural airflow over the fins.
- 2 - Driving high power levels into low impedances - back off on the volume control, and/or make sure you are not loading the amplifier with less than the recommended loudspeaker impedance.

## Low output power

- 1 - Check that level controls have been set up properly.
- 2 - Make sure that the battery voltage, as measured at the amplifier's +12 volt and ground terminals, is 11 volts or more.
- 3 - Check all +12 volt and ground connections.

## Fuses blowing

- 1 - The use of loudspeaker impedances below the recommended minimums will draw more current - check.
- 2 - A short on the main +12 volt cable from the battery to the vehicle chassis will cause the main fuse to blow.
- 3 - If an amplifier fuse blows continually, with only +12 volt, ground and remote leads connected, the amplifier may be faulty.

## System does not turn on

- 1 - Check all fuses.
- 2 - Check all connections.
- 3 - Measure the +12 volt and remote turn on voltages at the amplifier terminals. If these are non-existent or low, take voltage measurements at fuse holders, distribution blocks, the head unit's +12 volt and remote leads to localize the problem.

## Noise problems

System noise can be divided into two categories, hiss, and electrical interference.

### Hiss, or white noise

- 1 - High levels of white noise usually occurs when amplifier level controls are turned up too high - readjust according to the procedures in section "*Setting up systems after installation for best performance*".
- 2 - Another major problem that can cause excessive hiss, is a noisy head unit - unplug the amplifier input RCA cables, and if the hiss level reduces, the source unit is at fault.

### Electrical interference

The inside of an automobile is a very hostile electrical environment. The multitude of electrical systems, such as the ignition system, alternator, fuel pumps, air conditioners, to mention just a few, create radiated electrical fields, as well as noise on the +12 volt supply and ground. Remember to isolate the problem - first unplug amplifier input RCA cables, if the noise is still present, check the speaker leads, if not, plug the RCA's back, and investigate the source driving the amplifier, one component at a time.

### A ticking or whine that changes with engine RPM:

- 1 - This problem could be caused by radiation pickup of RCA cables too near to a fuel pump or a distributor, for instance, - relocate cables.
- 2 - Check that the head unit ground is connected straight to the vehicle chassis, and does not use factory wiring for ground.
- 3 - Try to supply the head unit with a clean +12 volt supply directly from the battery +, instead of using a supply from the in dash wiring/fusebox.

### A constant whine:

This type of noise can be more difficult to pinpoint, but is usually caused by some kind of instability, causing oscillations in the system.

- 1 - Check all connections, especially for good grounds.
- 2 - Make sure that no speaker leads are shorting to exposed metal on the vehicle chassis.
- 3 - RCA cables are notorious for their problematic nature, so check that these are good, in particular the shield connections.

# **autOTEK**

## **SUPER SPORT AT-SERIES**

### **Maxxsonics Limited Warranty**

**As the manufacturer of Maxxsonics, Autotek, Crunch, MB Quart and Hifonics car audio products Maxxsonics USA Inc. Warrants to the original consumer purchaser the amplifier to be free from defects in material and workmanship for one (1) Year from date of purchase.**

**All other parts and accessories of the system are warrantied to be free from defects in material and workmanship for one (1) year from date of purchase. Maxxsonics will repair or replace at it's option and free of charge during the warranty period, any system component that proves defective in materials and workmanship under normal installation, use and service provided that the product is returned to the authorized Maxxsonics dealer from where it was purchased. A photo copy of the original receipt must accompany the product being returned.**

**Valid purchase receipts will contain the name and address of the authorized reseller.**

**Any damage to the product as a result of misuse, abuse, accident, incorrect wiring, improper installation, alteration of date code or bar code labels, revolution, natural disaster, or any sneaky stuff because someone messed up, repair or alteration out side of our factory or authorized service centers and any thing else you have done that you should not have done is not covered.**

**This warranty is limited to defective parts and specifically excludes any incidental or consequential damages connected therewith. This warranty is not to be construed as an insurance policy.**

**Warranty on installation labor, removal, re-installation and freight charges are not the responsibility of Maxxsonics USA Inc.**

**Warranty products damaged as a result of insufficient or improper packing materials are not covered by this limited warranty and such damaged product will be returned "as is" at the expense of the owner.**



**MAXXSONICS™**

**Designed and Engineered in the USA**

**[www.maxxsonics.com](http://www.maxxsonics.com)**





**Autotek & Maxxsonics  
are part of the Maxxsonics USA, Inc. family**

**[www.maxxsonics.com](http://www.maxxsonics.com)  
847-540-7700**